

# Amphenol

62IN Series Miniature  
Circular Bayonet-Coupled  
Connectors AC6201 0717

The advertisement features a central collage of images. On the left, six different models of Amphenol 62IN connectors are displayed against a blue background with light rays and stars. The connectors vary in size, pin configuration, and mounting style. On the right, three smaller images show industrial applications: a factory assembly line with robotic arms, a high-speed train, and a control panel with several connectors installed. The overall theme is industrial reliability and precision.

# Amphenol



## Introduction

Amphenol 62IN series connectors are general purpose, environment resistant, miniature circular connectors with three-point bayonet coupling and five-key polarisation. Designed to meet the requirements of MIL-C-26482, Series I solder type, these connectors are widely used in applications calling for quick disconnect connectors.

62IN connectors are intermateable and interchangeable with all MIL-C-26482 connectors, whether solder or crimp type. These connectors are used worldwide in military and industrial applications and are available in a variety of sizes, styles and configurations.

Amphenol 62IN series connectors are also approved to Indian Defence Standard Joint Services Specifications JSS50813, certified by the Electronic Components Standardisation Organisation (LCSO), Bangalore, India.

Content	Page
Introduction	1
General description	2
Insert orientations	3
Key / Keyway orientations	4
Insert arrangements	5
Connector styles	6-11
Dust covers	12
Accessories	13-15
Back-Shell	16-18
Specials and deviations	19
Ordering 62IN series connectors	20

Amphenol 62IN series miniature circular bayonet-coupled solder connectors meet the most critical application needs. Design versatility and high reliability performance makes this series ideal for environmental sealing.

## Shell

Shell hardware is manufactured from aluminum alloy and cadmium plated with an olive drab chromate finish. This finish has excellent conductivity; it is non-reflecting and corrosion resistant. Black anodised finish and cadmium-free zinc cobalt plating are also available. For details, contact factory.

Shell styles consist of wall and box mounting receptacles, jam nut receptacles, cable mounting receptacles and straight plugs. Connectors are available in 9 shell sizes : 8, 10, 12, 14, 1, 18, 20, 22 and 24.

Positive shell-to-shell keying is provided with keys and keyways in a choice of either normal (N) or any of the preferred alternate positions: W,X,Y and Z. this prevents mismatching between shells of different orientations and overcomes the difficulties associated with rotated inserts and standard key/keyway orientation. in the latter system, damage to inserts or contacts can result if excessive force is used to engage non-mating halves.

## Insert and grommet

The insert and grommet are moulded from resilient neoprene, offering high dielectric strength and resistance to oils, gasoline and low temperature. This provides electrical isolation of the contacts in the insert and excellent moisture sealing.

## Contacts

Gold over nickel plated and socket contacts are machined from brass and designed for solder connections. Industrial version crimp contacts are also available on request.

## Specifications

Number of contacts	2 thru 61 in discrete steps		
Operating temperature	-55° C to +125° C		
Current rating			
Contact size	Rated current	Test current	Potential drop
20	7.5A	7.5A	≤ 55mV
16	13A	13A	≤ 50mV
Voltage rating (max. operating voltage at sea level)			
Service rating	AC (rms)		
I	600V		
II	1000V		
Insulation resistance	≥ 5000 Mohm		
Voltage proof			
Service rating	Test voltage (rms)		
I	1500V		
II	2300V		
Wire range accommodations			
Contact size	AWG wire size		
20	24, 22 and 20		
16	20, 18 and 16		

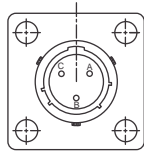

Normal position of insert with pin contacts

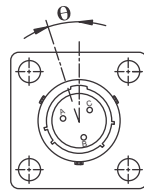

Alternate position of insert with socket contacts ( $\theta$  counterclockwise)

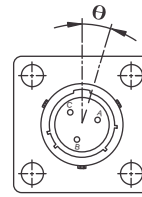

Alternate position of insert with pin contacts ( $\theta$  clockwise)

Each diagram shows mating face of insert

Insert arrangement	Orientation			
	W	X	Y	Z
8-2	58	122	-	-
8-3	60	210	-	-
8-4	45	-	-	-
8-33	90	-	-	-
8-98	-	-	-	-
10-2	-	-	-	-
* 10-5	90	-	-	-
10-6	90	-	-	-
10-7	-	-	-	-
10-8	-	-	-	-
12-3	-	-	180	-
12-4	38	-	-	-
12-8	90	112	203	292
12-10	60	155	270	295
12-12	-	-	-	-
12-14	60	155	270	295
*14-02	-	-	-	-
*14-04	45	-	-	-
14-05	40	92	184	273
*14-08	43	90	-	-
14-12	43	90	-	-
*14-14	17	110	155	234
14-15	17	110	155	234
14-18	15	90	180	270
14-19	30	165	315	-
16-8	54	152	180	331
16-23	158	270	-	-
16-26	60	-	275	338
*18-02	62	119	241	340
18-11	62	119	241	340
18-32	85	138	222	265
20-16	238	318	333	347
20-27	72	144	216	288
20-29	63	144	252	333
20-39	45	126	225	-
20-41	45	126	225	-
22-21	16	135	175	349
*22-36	16	135	175	349
22-41	39	135	264	-
*22-44	30	142	226	314
22-55	30	142	226	314
24-31	90	225	225	-
24-61	90	180	270	324

\* Special insert arrangements consult factory

# Insert Arrangements

Front face of pin insert or rear of socket insert illustrated

### Contact Legend

Symbol	●	○
Contact size	16	20

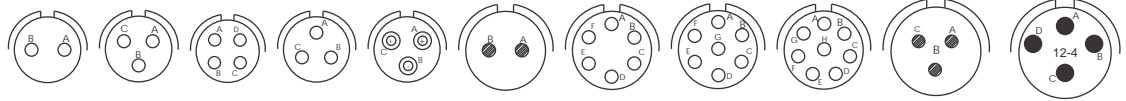

Insert arrangement	8-2	8-3	8-4	8-33	8-98	10-2	10-6	10-7	10-8	12-3	12-4
Service rating	I	I	I	I	I	II	I	I	I	II	II
Number of contacts	2	3	4	3	3	2	6	7	8	3	4
Contact size	20	20	20	20	20	16	20	20	20	16	16

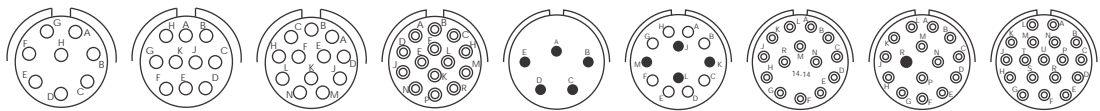

Insert arrangement	12-8	12-10	12-12	12-14	14-5	14-12	14-14	14-15	14-18
Service rating	I	I	I	I	II	I	I	I	I
Number of contacts	8	10	12	14	5	4 8	14	1 14	18
Contact size	20	20	20	20	16	16 20	20	16 20	20

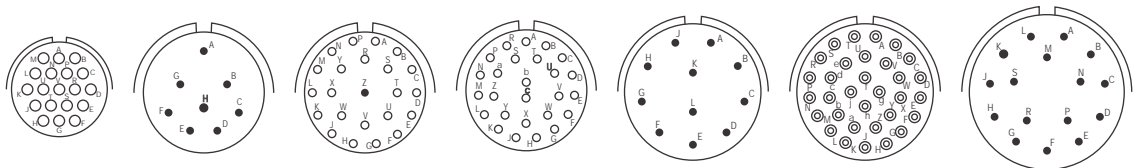

Insert arrangement	14-19	16-8	16-23	16-26	18-11	18-32	20-16
Service rating	I	II	I	I	II	I	II
Number of contacts	19	8	1 22	26	11	32	16
Contact size	20	16	16 20	20	16	20	16

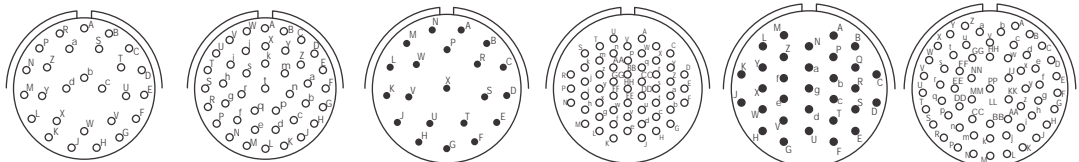

Insert arrangement	20-27	20-41	22-21	22-55	24-31	24-61
Service rating	I	I	II	I	I	I
Number of contacts	27	41	21	55	31	61
Contact size	20	20	16	20	16	20

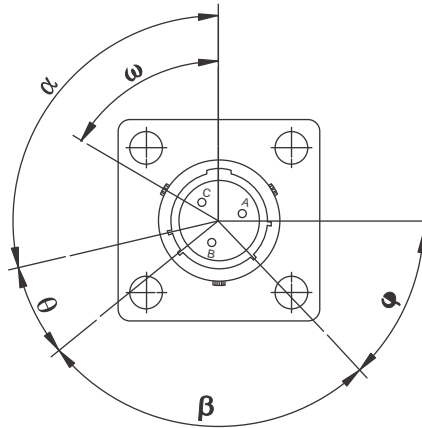

Shell size	Angles in degrees																			
	α					θ					β					φ				
	N	B	C	E	F	N	B	C	E	F	N	B	C	E	F	N	B	C	E	F
8	105	-	-	118	82	35	-	-	30	50	75	-	-	100	75	50	-	-	30	45
10	105	85	125	115	85	35	35	35	30	50	75	75	75	100	75	50	50	50	30	45
12	105	89	121	115	85	35	35	35	30	50	75	75	75	100	75	50	50	50	30	45
14	105	91	119	75	120	35	35	35	30	50	75	75	75	100	75	50	50	50	30	35
16	105	93	117	75	120	35	35	35	30	50	75	75	75	100	75	50	50	50	30	35
18	105	95	115	75	120	35	35	35	30	50	75	75	75	100	75	50	50	50	30	35
20	105	95	115	75	120	35	35	35	30	50	75	75	75	100	75	50	50	50	30	35
22	105	97	113	75	120	35	35	35	30	50	75	75	75	75	75	50	50	50	30	35
24	105	97	113	75	120	35	35	35	30	50	75	75	75	100	75	50	50	50	30	35

Shell size	Angle in degrees ω				
	N	B	C	E	F
8	60	-	-	73	47
10	60	40	80	70	50
12	60	44	76	70	50
14	60	46	74	30	75
16	60	48	72	30	75
18	60	50	70	30	75
20	60	50	70	30	75
22	60	52	68	30	75
24	60	54	68	30	75

Angles shown are with reference to the major key or keyway. In receptacles, the major keyway always remains fixed in relation to the mounting flange. For B, C, E and F orientations, the three bayonet locations and associated minor keyways are rotated completely as shown in the tables. The accompanying diagram shows a receptacle shell with keyways. Corresponding key orientations for a mating plug shell are therefore always clockwise.

## Wall Mounting Receptacles

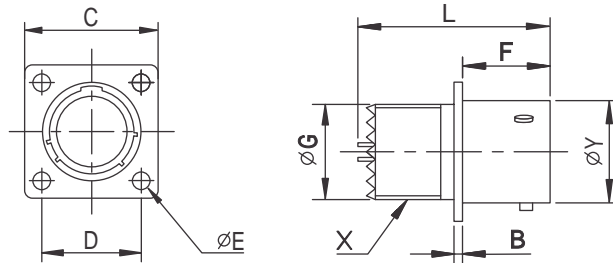
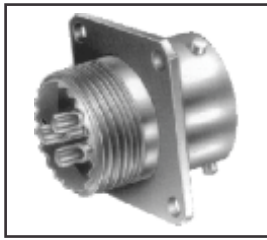

### Without termination assemblies

All dimensions in mm

Shell size	B	C	D	E Dia	F	G Dia	L	Y Dia	X threads in inches
8	1.58	20.75	15.09	3.05	11.30	11.02	24.84	12.02	7/16-28 UNEF
10	1.58	23.93	18.26	3.05	11.30	14.17	24.84	14.99	9/16-24 NEF
12	1.58	26.32	20.63	3.05	11.30	17.35	24.84	19.05	11/16-24 NEF
14	1.58	28.70	23.10	3.05	11.30	20.52	24.84	22.23	13/16-20 UNEF
16	1.58	31.07	24.61	3.05	11.30	23.70	24.84	25.40	15/16-20 UNEF
18	1.58	33.45	26.58	3.05	11.30	26.85	24.84	28.58	1 1/16-18 NEF
20	2.03	36.63	29.36	3.05	14.10	30.02	26.62	31.75	1 3/16-18 NEF
22	2.03	39.80	31.75	3.05	14.10	33.20	26.62	34.93	1 5/16-18 NEF
24	2.03	42.98	34.93	3.74	14.99	36.37	26.62	38.10	1 7/16-18 NEF

Note: Serrations / antirotation feature is not provided on shells for 10A, 10E and 10F styles.

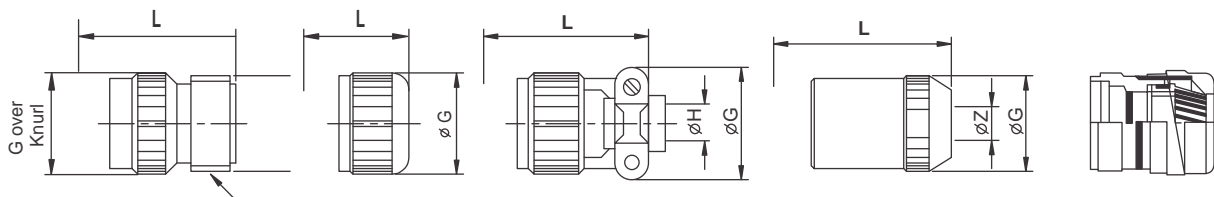

Style 10A

Style 10E

Style 10F

Style 10J

10PHM/EGM

### With termination assemblies

All dimensions in mm

Shell size	Style 10A			Style 10E		Style 10F			Style 10J			
	G Dia	L	M thread in inches	G Dia	L	G Dia	H Dia	L	G Dia	L	For cable size Z Dia	
											min	max
8	14.25	41.25	1/2-28 UNEF	14.25	32.54	21.03	3.96	44.76	14.25	46.89	4.28	5.84
10	17.43	41.25	5/8-24 NEF	17.43	32.54	22.63	4.78	44.76	17.43	46.89	5.21	7.93
12	20.60	41.25	3/4-20 UNEF	20.60	32.54	25.81	7.93	44.76	20.80	49.45	8.59	11.23
14	23.78	41.25	7/8-20 UNEF	23.78	32.54	28.98	9.58	44.10	23.78	54.54	10.57	13.69
16	26.98	41.25	1-20 UNEF	26.98	32.54	30.56	12.70	47.65	26.98	59.61	13.97	15.65
18	30.12	41.25	1 3/16-18 NEF	30.12	32.54	36.22	15.87	47.65	30.12	64.70	15.24	17.07
20	33.30	42.85	1 3/16-18 NEF	33.30	35.13	36.22	15.87	53.80	33.30	71.91	16.13	18.98
22	36.47	42.85	1 7/16-18 NEF	36.47	35.13	39.80	19.05	53.80	36.47	76.99	17.02	21.49
24	39.65	43.94	1 7/16-18 NEF	39.65	35.13	44.07	20.32	57.15	39.65	78.08	18.80	22.71



## Box Mounting Receptacles

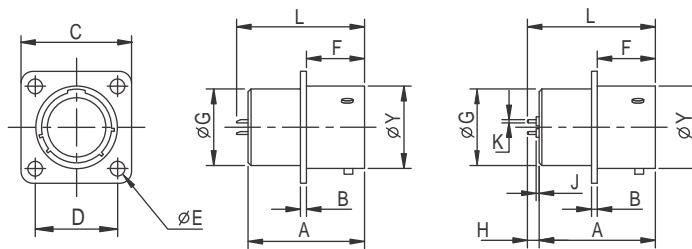

Style 12E  
solder

Style 12E(219)  
film wire terminations

All dimensions in mm

Shell size	B	C	D	E Dia	F	G Dia	Y Dia	Style 12E		Style 12E(219)						
								A	L	A	H		J	K		L
											min	max		min	max	
8	1.58	20.75	15.09	3.05	11.30	11.02	12.02	20.32	24.84	20.32	4.22	5.03	2.26	0.70	0.76	24.95
10	1.58	23.93	18.26	3.05	11.30	14.17	14.99	20.32	24.84	20.32	4.22	5.03	2.26	0.70	0.76	24.95
12	1.58	26.32	20.63	3.05	11.30	17.35	19.05	20.32	24.84	20.32	4.22	5.03	2.26	0.70	0.76	24.95
14	1.58	28.70	23.01	3.05	11.30	20.52	22.23	20.32	24.84	20.32	4.22	5.03	2.26	0.70	0.76	24.95
16	1.58	31.07	24.61	3.05	11.30	23.70	25.40	20.32	24.84	20.32	4.22	5.03	2.26	0.70	0.76	24.95
18	1.58	33.45	26.97	3.05	11.30	26.85	28.58	20.32	24.84	20.32	4.22	5.03	2.26	0.70	0.76	24.95
20	2.03	36.63	29.36	3.05	14.10	30.02	31.75	22.23	26.62	22.23	3.89	4.70	1.93	0.70	0.76	26.85
22	2.03	39.80	31.75	3.05	14.10	33.20	34.93	22.23	26.62	22.23	3.89	4.70	1.93	0.70	0.76	26.85
24	2.03	42.98	34.93	3.74	14.99	36.37	38.10	22.23	26.62	22.23	3.89	4.70	1.93	0.70	0.76	26.85

### Mounting data

#### Panel cutouts

#### Wall mounting receptacles

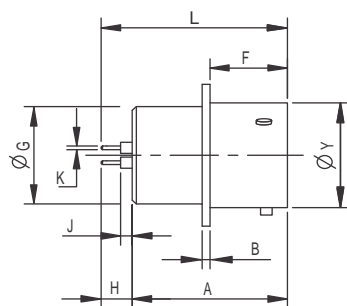

Style 12E(220)  
film wire terminations

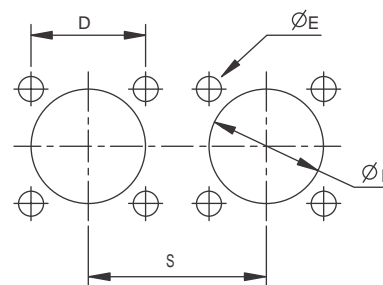

All dimensions in mm

Shell size	A	H		J	K		L
		min	max		min	max	
		8	20.32		7.95	8.00	
10	20.32	7.95	8.00	4.60	0.70	0.76	28.32
12	20.32	7.95	8.00	4.60	0.70	0.76	28.32
14	20.32	7.95	8.00	4.60	0.70	0.76	28.32
16	20.32	7.95	8.00	4.60	0.70	0.76	28.32
18	20.32	7.95	8.00	4.60	0.70	0.76	28.32
20	22.23	7.95	8.00	4.60	0.70	0.76	30.23
22	22.23	7.95	8.00	4.60	0.70	0.76	30.23
24	22.23	7.95	8.00	4.60	0.70	0.76	30.23

Shell size	D	E Dia	R Dia	S
8	15.09	3.05	14.42	31.73
10	18.26	3.05	17.53	34.52
12	20.63	3.05	21.84	38.89
14	23.01	3.05	25.15	42.06
16	24.61	3.05	28.19	45.24
18	26.97	3.05	31.49	48.03
20	29.36	3.05	35.54	51.59
22	31.75	3.05	37.85	52.76
24	34.93	3.74	41.15	57.84

- Note: 1) Style 220 is also available for 57A type receptacles with similar termination dimensions as 12E(220) style shown above.  
2) For other available PC tail contact detail, contact factory.

## Jam Nut Receptacles

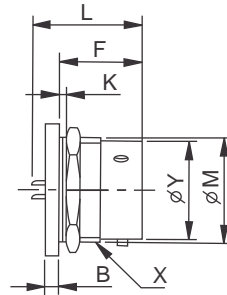
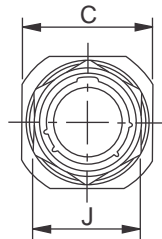
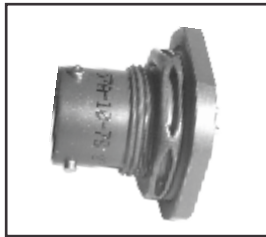

Style 57A  
solder

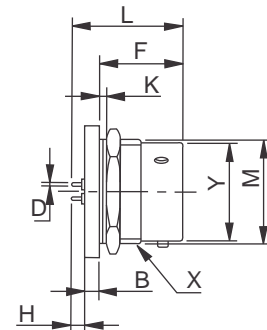

Style 57A(219)  
film wire terminators

### Without termination assemblies

All dimensions in mm

Shell size	B	C	D		F	H		J	K Panel Thickness		Style 57A L	Style 57A (219) L	M Dia.	Y Dia.	X Thread in inches
			Min.	Max.		Min.	Max.		Min.	Max.					
			8	2.97		23.93	0.70		0.76	17.93					
10	2.97	27.10	0.70	0.76	17.93	3.38	4.40	22.23	1.58	3.18	24.84	24.79	16.56	14.99	11/16-24 NEF
12	2.97	31.88	0.70	0.76	17.93	3.38	4.40	26.98	1.58	3.18	24.84	24.79	20.70	19.05	7/8-20 UNEF
14	2.97	35.05	0.70	0.76	17.93	3.38	4.40	30.15	1.58	3.18	24.84	24.79	23.85	22.26	1-20 UNEF
16	2.97	38.23	0.70	0.76	17.93	3.38	4.40	33.32	1.58	3.18	24.84	24.79	27.00	25.40	1 1/8-18 NEF
18	2.97	41.40	0.70	0.76	17.93	3.38	4.40	36.50	1.58	3.18	24.84	24.79	30.18	28.58	1 1/4-18 NEF
20	3.76	46.15	0.70	0.76	22.71	3.38	4.40	38.68	1.58	6.35	26.62	30.35	33.35	31.75	1 3/8-18 NEF
22	3.76	49.33	0.70	0.76	22.71	3.38	4.40	42.85	1.58	6.35	26.62	30.35	36.53	34.93	1 1/2-18 NEF
24	3.76	52.50	0.70	0.76	23.55	3.38	4.40	46.05	1.58	6.35	26.62	30.35	39.70	38.10	1 5/8-18 NEF

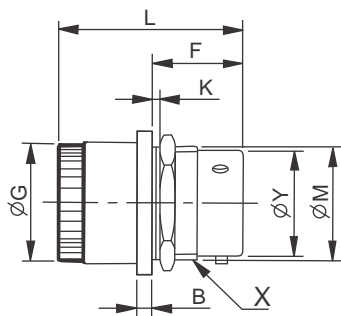

Style 14E

### Mounting data Panel cutouts

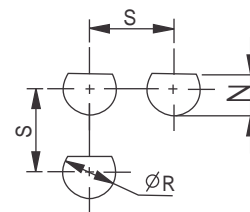

### With termination assemblies

All dimensions in mm

Shell size	G Dia.	L
8	18.11	34.14
10	21.29	34.14
12	24.46	34.14
14	27.63	34.14
16	30.81	34.14
18	33.98	34.14
20	37.16	40.03
22	40.33	40.03
24	43.51	40.87

Shell size	N	R Dia.	S
8	13.72	14.53	31.75
10	16.89	17.70	34.52
12	21.03	22.48	38.89
14	24.18	25.65	42.06
16	27.33	28.83	45.24
18	30.50	32.00	48.03
20	33.68	35.18	51.59
22	36.86	38.35	54.76
24	40.03	41.45	57.84

## Jam Nut Receptacles

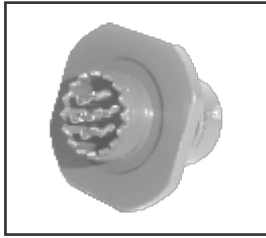

**62 IN - 57T**  
Single hole mounting with threaded shell to accept accessories

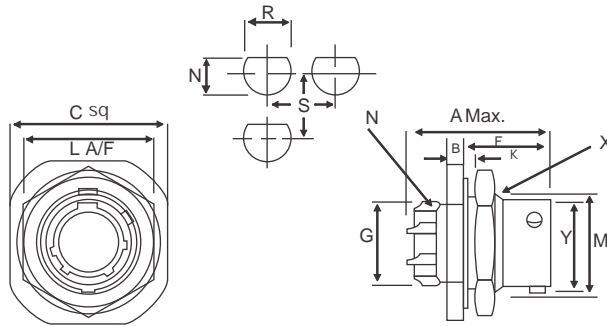

All dimensions in mm

Shell Size	A max	B $\pm 0.05$ ( $\pm 0.13$ )	C max sq.	F $\pm 0.005$ ( $\pm 0.13$ )	G Dia. Max.	K		L	M $-0.005$ ( $-0.13$ )	N	Y	X Thread
						min	Max					
08	0.978 24.84	0.117 2.97	0.942 23.93	0.595 15.12	0.426 10.82	0.062 1.58	0.125 3.58	0.750 19.05	0.527 13.3	7/16-28 UNEF	0.473 12.03	9/16-24 NEF
10	0.978 24.84	0.117 2.97	1.067 27.10	0.595 15.12	0.552 14.02	0.062 1.58	0.125 3.18	0.875 22.23	0.652 16.56	9/16-24 UNEF	0.590 14.99	11/16-24 NEF
12	0.978 24.84	0.117 2.97	1.255 31.88	0.595 15.12	0.677 17.20	0.062 1.58	0.125 3.18	1.062 26.98	0.825 20.70	11/16-24 UNEF	0.750 19.05	7/8-20 UNEF
12	0.978 24.84	0.117 2.97	1.380 35.05	0.595 15.12	0.802 20.37	0.062 1.58	0.125 3.18	1.187 30.15	0.939 23.85	13/16-20 UNEF	0.875 22.23	1-20 UNEF
16	0.978 24.84	0.117 2.97	1.505 38.23	0.595 15.12	0.927 23.55	0.062 1.58	0.125 3.18	1.312 33.32	1.063 27.00	15/16-20 UNEF	1.000 25.40	1.1/18-18 NEF
18	0.978 24.84	0.117 2.97	1.630 41.40	1.595 15.12	1.052 26.72	0.062 1.58	0.125 3.18	1.437 36.50	1.188 30.18	1 1/16-18 UNEF	1.125 28.58	1.1/4-18 NEF
20	1.048 26.62	0.148 3.76	1.817 46.15	0.720 18.29	1.167 29.65	0.062 1.58	0.250 6.35	1.562 38.68	1.313 33.35	1 3/16-18 UNEF	1.250 31.75	1.3/8-18 NEF
22	1.048 26.62	0.148 3.76	1.942 49.33	0.720 18.29	1.292 32.82	0.062 1.58	0.250 6.35	1.687 42.85	1.438 36.53	1 5/16-18 UNEF	1.375 34.93	1.1/2-18 NEF
24	1.048 26.62	0.148 3.76	2.067 52.50	0.753 19.13	1.416 35.97	0.062 1.58	0.250 6.35	1.812 46.05	1.563 39.70	1 7/16-18 UNEF	1.500 38.10	1.5/8-18 NEF



**62 IN - 14F**  
Single hole mounting with grommet and grommet nut fitted with integral strain relief clamp has panel 'O' ring seal

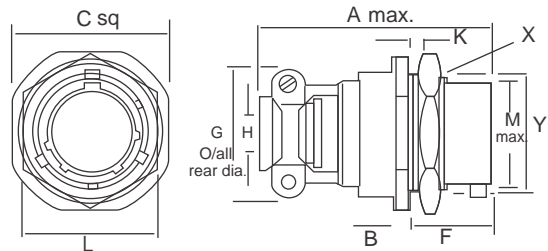

Shell Size	A max	B $\pm 0.05$ ( $\pm 0.13$ )	C max sq.	F $\pm 0.005$ ( $\pm 0.13$ )	G dia max	H $\pm 0.005$ ( $\pm 0.13$ )	K		L	M $-0.005$ ( $-0.13$ )	N $\pm 0.005$ ( $\pm 0.13$ )	R $\pm 0.005$ ( $\pm 0.13$ )	S	Y	X Thread
							min	3.18							
08	1.762 44.75	0.117 2.97	0.942 23.93	0.706 17.93	0.828 21.03	0.156 3.96	0.062 1.58	0.750 3.175	0.125 19.50	0.527 13.3	0.540 13.72	0.572 14.53	1.250 31.75	0.473 12.03	9/16-24 NEF
10	1.762 44.75	0.117 2.97	0.067 27.10	0.706 17.93	0.891 22.63	0.188 4.78	0.062 1.58	0.125 3.18	0.875 22.23	0.652 16.56	0.665 16.89	0.697 17.70	1.359 34.52	0.590 14.99	11/16-124 NEF
12	1.762 44.75	0.117 2.97	1.255 31.88	0.706 17.93	1.016 25.81	0.312 7.93	0.062 1.58	0.125 3.18	1.062 26.98	0.815 20.70	0.828 21.03	0.885 22.48	1.531 38.89	0.750 19.05	7/8-20 UNEF
14	1.736 44.10	0.117 2.97	1.380 35.05	0.706 17.93	1.141 28.97	0.375 9.35	0.062 1.58	0.125 3.18	1.187 30.15	0.939 23.85	0.952 24.18	1.010 25.65	1.656 42.06	0.875 22.23	1-20 UNEF
16	1.876 47.65	0.117 2.97	1.505 38.23	0.706 17.93	1.203 30.56	0.500 12.7	0.062 1.58	0.125 3.18	1.312 33.32	1.063 27.00	1.076 27.33	1.135 28.83	1.781 45.24	1.000 25.40	1.1/8-18 NEF
18	1.876 47.65	0.117 2.97	1.630 41.40	0.706 17.93	1.426 36.22	0.625 15.88	0.062 1.58	0.125 3.175	1.437 36.50	1.188 30.18	1.201 30.50	1.260 32.00	1.891 48.03	1.125 28.58	1.1/4-18 NEF
20	2.118 53.8	0.148 3.76	1.817 46.15	0.894 22.71	1.426 36.22	0.625 15.88	0.062 1.58	0.250 6.35	1.562 38.68	1.313 33.35	1.326 33.68	1.385 35.18	2.031 51.59	1.250 31.75	1.3/8-18 NEF
22	2.118 53.8	0.148 3.76	1.942 49.33	0.894 22.71	1.567 39.80	0.750 19.05	0.062 1.58	0.250 6.35	1.687 42.85	1.438 36.53	1.451 36.86	1.510 38.35	2.156 54.76	1.375 34.93	1.1/2-18 NEF
24	2.250 57.15	0.148 3.76	2.067 52.50	0.927 23.55	1.735 44.07	0.800 20.32	0.062 1.58	0.250 6.35	1.812 46.05	1.563 39.70	1.576 40.03	1.635 41.45	2.277 57.84	1.500 38.10	1.5/8-18 NEF

## Cable Mounting Receptacles

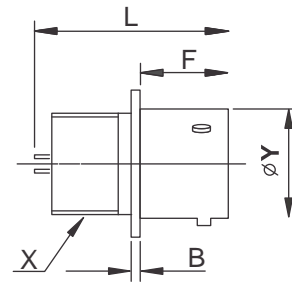
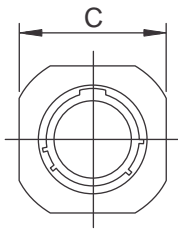
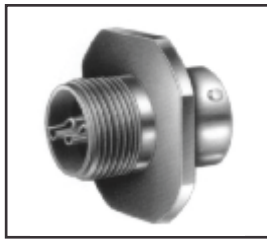

### Without termination assemblies

All dimensions in mm

Shell size	B	C	F	L	Y Dia	X thread in inches
8	2.39	20.75	10.54	24.84	12.03	7/16-28 UNEF
10	2.39	23.93	10.54	24.84	14.99	9/16-24 NEF
12	2.39	26.32	10.54	24.84	19.05	11/16-24 NEF
14	2.39	28.70	10.54	24.84	22.23	13/16-20 UNEF
16	2.39	31.07	10.54	24.84	25.40	15/16-20 UNEF
18	2.39	33.45	10.54	24.84	28.58	1 1/16-18 NEF
20	2.59	36.63	13.59	26.62	31.75	1 3/16-18 NEF
22	2.59	39.80	13.59	26.62	34.93	1 5/16-18 NEF
24	2.59	42.98	14.53	26.62	38.10	1 7/16-18 NEF

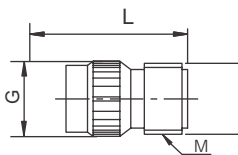

Style 11A

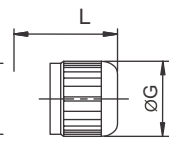

Style 11E

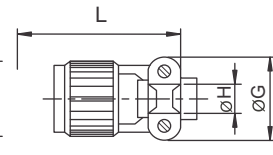

Style 11F

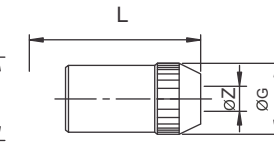

Style 11J



11PHM/EGM

### With termination assemblies

All dimensions in mm

Shell size	Style 11A			Style 11E		Style 11F			Style 11J			
	G Dia	L	M thread in inches	G Dia	L	G Dia	H Dia	L	G Dia	L	For cable size Z Dia	
8	14.25	41.25	1/2-28 UNEF	14.25	32.54	21.03	3.96	44.76	14.25	46.89	4.28	5.84
10	17.43	41.25	5/8-24 NEF	17.43	32.54	22.63	4.78	44.76	17.43	46.89	5.21	7.93
12	20.60	41.25	3/4-20 UNEF	20.60	32.54	25.81	7.93	44.76	20.60	49.45	8.59	11.23
14	23.78	41.25	7/8-20 UNEF	23.78	32.54	28.97	9.53	44.10	23.78	54.54	10.57	13.69
16	26.95	41.25	1-20 UNEF	26.95	32.54	30.56	12.70	47.65	26.95	59.61	13.97	15.65
18	30.13	41.25	1 3/16-18 NEF	30.13	32.54	36.22	15.88	47.65	30.13	64.70	15.24	17.07
20	33.30	42.85	1 3/16-18 NEF	33.30	35.13	36.22	15.88	53.80	33.30	71.91	16.13	18.98
22	36.75	42.85	1 7/16-18 NEF	36.75	35.13	39.80	19.05	53.80	36.75	76.99	17.02	21.49
24	39.65	43.95	1 7/16-18 NEF	39.65	35.13	44.07	20.32	57.15	39.65	78.03	18.80	22.71

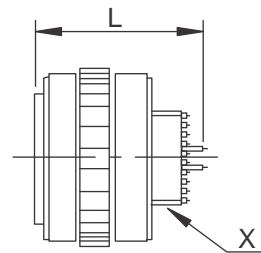
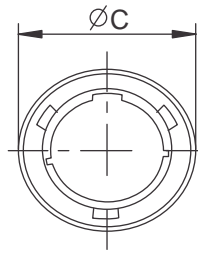

### Without termination assemblies

All dimensions in mm

Shell size	C Dia	L	X in inches
8	19.60	24.79	7/16-28 UNEF
10	22.35	24.79	9/16-24NEF
12	26.49	24.79	11/16-24 NEF
14	29.90	24.79	13/16-20 UNEF
16	33.07	24.79	15/16-20 UNEF
18	35.33	24.79	1 1/16-18 NEF
20	38.89	26.79	1 3/16-18 NEF
22	42.06	26.79	1 5/16-18 NEF
24	45.14	26.79	1 7/16-18 NEF

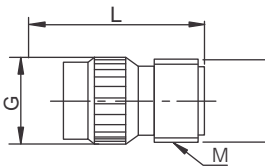

Style 16A

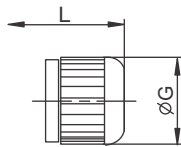

Style 16E

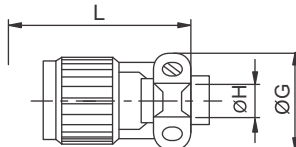

Style 16F

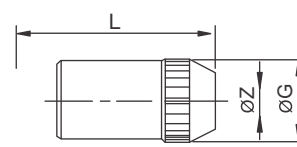

Style 16J

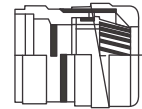

16PHM/EGM

### With termination assemblies

Shell size	Style 16 A			Style 16 E		Style 16 F			Style 16 J			
	G Dia	L	M Thread In Inches	G Dia	L	G Dia	H Dia	L	G Dia	L	For cable size Z Dia	
											min	max
8	14.25	41.00	1/2-28 UNEF	14.25	32.54	21.03	3.96	44.50	14.25	46.64	4.28	5.84
10	17.43	41.00	5/8-24 NEF	17.43	32.54	22.63	4.78	44.50	17.43	46.64	5.21	7.93
12	20.60	41.00	3/4-20 UNEF	20.60	32.54	25.81	7.93	44.50	20.60	49.20	8.59	11.23
14	23.78	41.00	7/8-20 UNEF	23.78	32.54	28.97	9.53	43.84	23.78	54.28	10.57	13.69
16	26.95	41.00	1-20 UNEF	26.95	32.54	30.56	12.70	47.40	26.95	59.36	13.97	15.65
18	30.13	41.00	1 3/16-18 NEF	30.13	32.54	36.22	15.88	47.40	30.13	64.45	15.24	17.07
20	33.30	41.00	1 3/16-18 NEF	33.30	32.54	36.22	15.88	51.81	33.30	70.05	16.13	18.98
22	36.75	41.00	1 7/16-18 NEF	36.75	32.54	39.80	19.05	51.81	36.75	75.13	17.02	21.49
24	39.65	42.11	1 7/16-18 NEF	39.65	32.54	44.07	20.32	55.32	39.65	76.25	18.80	22.71

Notes: 1. Plugs are also available with heavy duty ribbed coupling ring, to order, add deviation (044) at the end of plug part number.

## Metallic Dust Covers

Standard is olive drab chromate finish over cadmium plating with straight knurling. To order add suffix **-XX** to required style, where XX specifies shell size. It is strongly recommended that these are fitted to provide protection when connectors are not in use. For alternate finishes or dust covers with heavy duty ribs, contact factory for further details and part number. Dust cap with Nylon cord is also available. Contact factory for further details.

### For receptacles

Dust cover style		To fit receptacle style
with chain	with nylon cord	
62IN-736	62IN-813	Jam nut
62IN-737	62IN-814	Cable mounting
62IN-738	62IN-812	Wall and box mounting

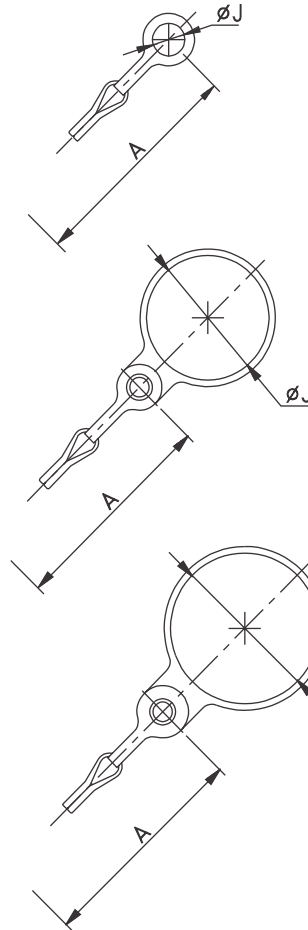
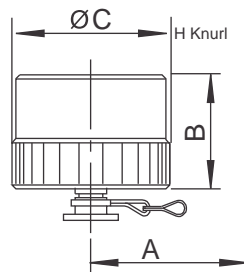

### For plugs

Dust cover style	
with chain	with nylon cord
62IN-742	62IN-810

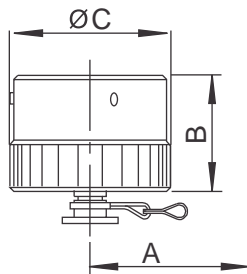

All dimensions in mm

Shell size	C For Plug Max.	A chain / cord length	B		C Dia receptacles	J Dia		
			for receptacles	for plugs		736 813	737 814	738 812 742 810
8	18.26	76.20	14.27	14.27	18.64	14.68	11.63	4.49 max.
10	21.44	76.20	14.27	14.27	21.82	17.86	14.81	4.49 max.
12	25.40	88.90	14.27	14.27	25.40	22.63	17.98	4.49 max.
14	28.58	88.90	14.27	14.27	28.57	25.81	22.76	4.49 max.
16	31.75	88.90	14.27	14.27	31.75	29.39	25.93	4.49 max.
18	34.92	88.90	14.27	14.27	34.92	32.16	29.11	4.49 max.
20	38.10	101.60	14.27	15.88	38.10	35.33	32.28	4.49 max.
22	41.28	101.60	14.27	15.88	41.27	38.51	35.46	4.49 max.
24	44.45	101.60	15.29	16.71	44.45	41.68	38.63	4.49 max.

Notes: For more detailed information refer connector Accessory catalog.

## Strain Relief Clamp With Grommet

(Replace XX-XX with the required insert arrangement)

62IN-585-XX-XXS or XXP

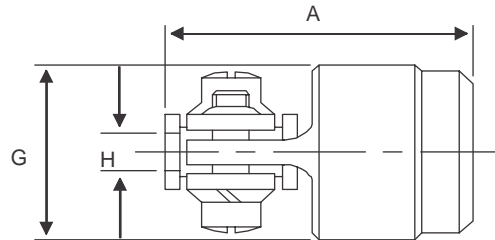

All dimensions in mm

Shell size	A max	G max	H max
8	25.17	21.03	4.09
10	25.17	22.63	4.90
12	25.17	25.81	8.05
14	24.51	28.98	9.65
16	28.07	30.56	12.83
18	28.07	36.22	16.00
20	32.64	36.22	16.00
22	32.64	39.80	19.18
24	34.88	44.07	20.45

## Shell To Accept Conduit

(Replace XX with the required shell size)

62IN-776-XX

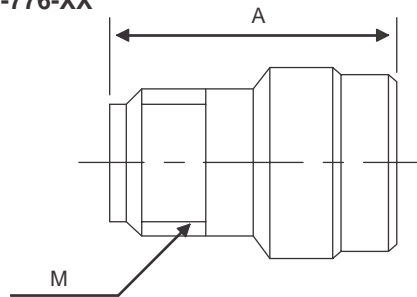

All dimensions in mm

Shell size	A max	M Thread in inches
8	23.80	1/2-28 UNEF
10	23.80	5/8-24 NEF
12	23.80	3/4-20 UNEF
14	23.80	7/8-20 UNEF
16	23.80	1-20 UNEF
18	23.80	1 3/16-18 NEF
20	23.80	1 3/16-18 NEF
22	23.80	1 7/16-18 NEF
24	23.80	1 7/16-18 NEF

## 62IN - SQ Adaptors

For Shielded Cables

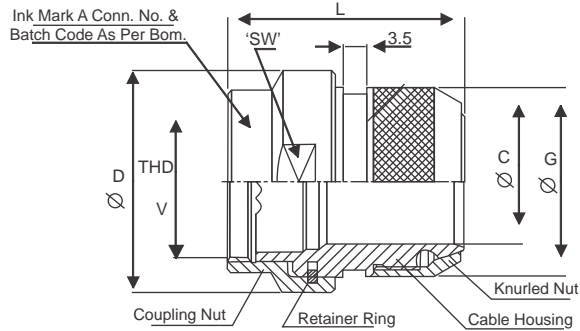

SIZE	ATX P/NO.	'V' THD. UNEF-2B	Ø C MIN.	Ø D MAX.	Ø G +0.5 -0.0	L MAX.	SW -0.2	RECOMMEN- DED TORQUE'S (Nm)
08	62IN-08-SQ	7/16 -28	6.6	20	16	36	18	4 +0.50
10	62IN-10-SQ	9/16 -24	9.2	23	18	36	21	6 +0.50
12	62IN-12-SQ	11/16 -24	12.2	27	22	36	24	8±1.0
14	62IN-14-SQ	13/16 -20	15.2	30	25	37	28	10±1.0
16	62IN-16-SQ	15/16 -20	18.3	33	28		31	
18	62IN-18-SQ	1 1/16 -18	20.0	36	32		34	13±1.0
20	62IN-20-SQ	1 3/16 -18	23.0	40	34		37	
22	62IN-22-SQ	1 5/16 -18	26.0	43	38		41	
24	62IN-24-SQ	1 7/16 -18	28.8	46	41	37	44	

## 62IN - Shrink Boot Adaptors

For Unshielded Cables

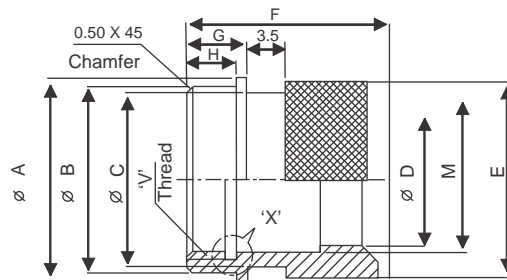
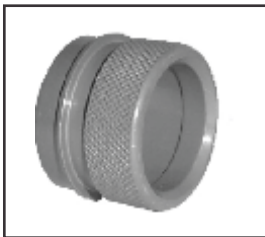

SIZE	ATX P/NO	Ø 'A' -0.3	Ø 'B'	Ø 'C' -0.2	Ø 'D' +0.2	Ø 'E' +0.5	'F'	'G'	'H'	'V' THREAD. UNEF -2B	'M' +0.1	
08	62IN-108559	15.4	14.0	13.1	9.2	15.1	17.5	5.50	4.50	7/16 -28	10.2	
10	62IN-108560	18.6	17.0	15.9	12.1	17.9				9/16 -24	13.3	
12	62IN-108561	21.8	20.3	21.2	15.1	23.2				11/16 -24	16.5	
14	62IN-108562	25.0	23.3	22.1	18.4	24.0				13/16 -20	19.5	
16	62IN-108563	28.2	26.4	26.0	21.6	29.3				20.0	15/16 -20	22.6
18	62IN-108564	31.3	29.5	28.4	24.1	31.5				20.0	1 1/16 -18	25.6
20	62IN-108565	34.5	32.7	32.3	27.3	35.6				21.3	1 3/16 -18	28.8
22	62IN-108566	37.7	35.8	34.7	30.5	38.0				21.3	1 5/16 -18	32.0
24	62IN-108567	40.9	39.0	37.9	33.7	41.0	20.0	5.00	4.00	1 7/16 -18	35.2	



## Flange Mounting Gasket

### 62IN-760-XX

(Replace XX with the required shell size)

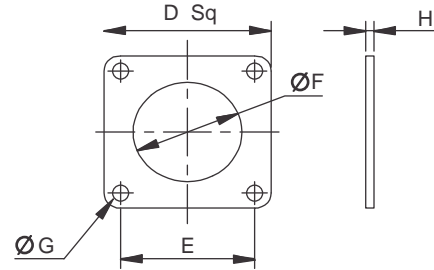
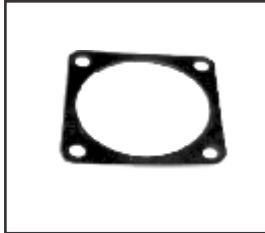

All dimensions in mm

Shell size	D	E	F Dia	G Dia	H max
8	20.62	15.08	12.90	3.30	1.06
10	23.82	18.26	16.07	3.30	1.06
12	26.18	20.65	19.25	3.30	1.06
14	28.57	23.01	22.42	3.30	1.06
16	30.96	24.61	25.60	3.30	1.06
18	33.32	27.00	28.77	3.30	1.06
20	36.52	29.36	31.95	3.30	1.06
22	39.70	31.75	35.13	3.30	1.06
24	42.87	34.92	38.30	3.96	1.06

## PG Adaptors with 'O' ring

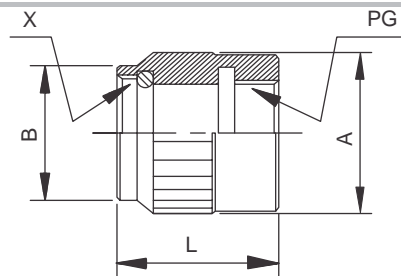
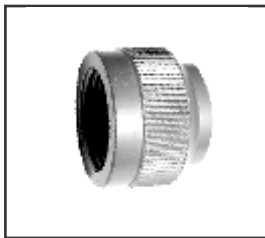

All dimensions in mm

Part number	For shell size	X Thread in inches	A	B	L	PG Thread
62IN08-PG7	8	7/16-28 UNEF	16.50	14.50	20.00	PG7
62IN10-PG9	10	9/16-24 NEF	22.00	17.70	20.00	PG9
62IN12-PG9	12	11/16-24 NEF	22.00	21.00	20.00	PG9
62IN14-PG13.5	14	13/16-20UNEF	28.00	23.50	25.00	PG13.5
62IN16-PG9	16	15/16-20 UNEF	29.00	27.80	30.00	PG 9
62IN18-PG16	18	1 1/16-18 NEF	31.50	31.00	35 .00	PG16
62IN20-PG21	20	1 3/16-18 NEF	35.00	34.00	40.00	Pg21
62IN22PG13.5	22	1 5/16 NEF	26.00	37.20	40.00	PG13.5
62IN24-PG16	24	1 7/16-18 NEF	41.50	40.50	40.00	PG16

## EGM/PHM Adaptor

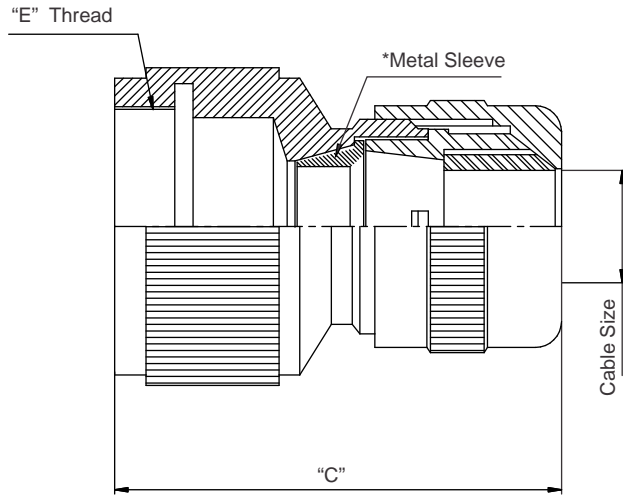

\*EGM - Supplied with metal sleeve for shielded cable  
 PHM - Supplied without metal sleeve for unshielded cable

Shell size	"C" Ref.	PG Size (Cable Size in mm)	"E" Thread For Straight
8	30.00	PG 11	7/16" -28 UNEF
10		PG 11	9/16" -24 NEF
12		PG 11	11/16" -24 NEF
14		PG 21	13/16" -20 UNEF
16		PG 21	15/16" -20 UNEF
18		PG 21	1 1/16" -20 UNEF
20	35.00	PG 21	1 3/16" -18 UNEF
22		PG 21	1 5/16" -18 NEF
24		PG 21	1 7/16" -18 UNEF

EGM/PHM11 Can accept cable Min 5.70 mm & Max 10.85 mm  
 EGM/PHM21 Can accept cable Min 12.70 mm & Max 17.85 mm

## Shrink Boot Adaptor

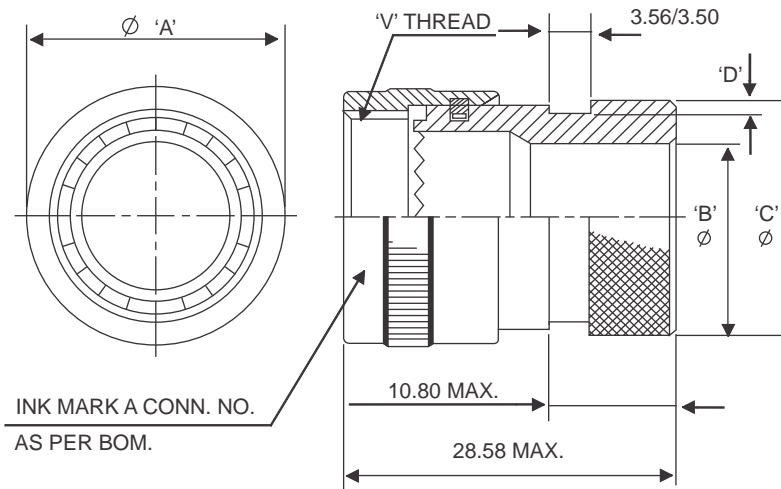

SHELL SIZE	ØA MAX.	ØB MIN.	ØC + 0.0 - 0.51	D + 0.20 - 0.0	'V' THREAD UNEF-2B	CONNECTORS P/NO.
08	15.67	6.35	13.54	1.12	7 / 16" -28	M85049 / 60-1-W-8-IN
10	18.64	9.02	15.37		9 / 16" -24	M85049 / 60-1-W-10-IN
12	21.79	12.47	19.66		11 / 16" -24	M85049 / 60-1-W-12-IN
14	24.99	14.35	21.29		13 / 16" -20	M85049 / 60-1-W-14-IN
16	28.24	17.53	24.46		15 / 16" -20	M85049 / 60-1-W-16-IN
18	30.94	19.53	26.47		1 1 / 16" -18	M85049 / 60-1-W-18
20	34.16	22.71	30.91	1.75	1 3 / 16" -18	M85049 / 60-1-W-20
22	32.79	25.88	34.42		1 5 / 16" -18	M85049 / 60-1-W-22
24	40.46	28.80	36.65		1 7 / 16" -18	M85049 / 60-1-W-24

## Right Angle Backshell

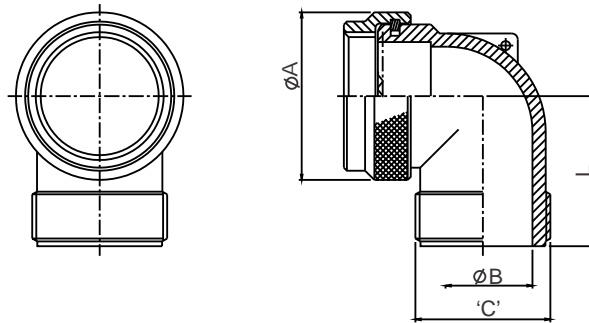

Shell Size	DRG. No.	ØA MAX.	ØB ±0.13	'C' -2A THREAD.	L MAX.
8	500238-8	18.85	7.30	9/16"-24NEF	20.80
10	500238-10	21.70	10.18	5/8"-24UNEF	21.70
12	500238-12	24.60	13.35	3/4"-20UNEF	23.35
14	500238-14	27.85	16.26	7/8"-20UNEF	24.85
16	500238-16	31.2.	19.40	1"-20UNEF	26.45
18	500238-18	34.15	22.00	1 3/16"-18UNEF	28.70
20	500238-20	37.25	24.20		29.60
22	500238-22	40.65	28.50	1 7/16"-18NEF	31.60
24	500238-24	44.00	31.65		33.60

## JC Clamp Backshell

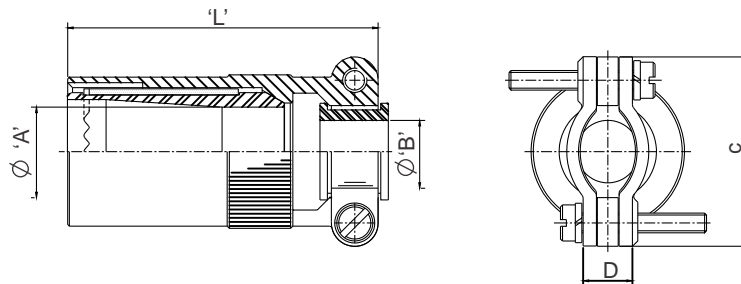

Shell Size	A		B ±0.13	C MAX.	D MAX Closed	'L' MAX.
	MIN.	MAX.				
8	4.28	5.84	3.96	21.03	4.75	40.50
10	5.21	7.93	4.78	22.63		
12	8.59	11.23	7.93	25.81		
14	10.57	13.69	9.58	28.97	8.26	48.00
16	13.97	15.65	12.70	30.56	9.04	54.50
18	15.24	17.07	15.88	36.22	11.58	59.00
20	16.13	18.98	15.88	36.22	13.18	67.00
22	17.02	21.49	19.05	39.80		73.40
24	18.80	22.71	20.32	44.07	16.69	77.00

## Industrial Version Crimp Contacts

62IN series connectors are also available with rear release crimp contacts for industrial applications. These contacts can be crimped to wires outside the connector and then inserted into place with the help of designated tools. Connector maintenance is simplified because damaged contacts can be removed by using the designated removal tool and replaced with a new contact. Spare contacts are also available.

### Standard deviations for finishes & features

Deviation number	Description
(4)	Gold flash on contacts
(5)	Crimp contact
(044)	Rough grip heavy duty coupling ring (for plugs only)
(218)	Coupling ring with lever arrangement
(219)	Film wire termination (short) for flexible printed wiring (57A and 12E styles only)
(220)	Film wire termination (long) for flexible printed wiring (57A and 12E styles only)
(221-231)	Different film wire PC tail contact for flexible printed wiring (57A & 12E styles only- Details contact factory)
(416)	Electroless Nickel Plating
*(608)	Black anodised finish
(622)	Cadmium free zinc-cobalt Plating-olive drab finish
(624)	Cadmium free zinc-cobalt Plating-black finish
(0PX)	Premating contact (X denotes premating contact designation)
(714)	Cadmium over electroless Nickel
(720)	Cadmium plating with black chromate
(725)	Zinc plating with olive drab finish
(726)	Electrophoratic Finish
(56T)	Plug connector with threaded shell & serration to accept the cable accessories
(15A)	Plug connector with threaded shell to accept the cable accessories
(LC)	Less contact

C04:-Crimp connectors with few solder contact (Position need to mention)

### Specials

For special requirements, please contact factory with specifications and drawings. Amphenol has in-house capability to meet and custom build your special requirements for its range of MIL-C-26482 62IN series connectors.

\* Consult factory for availability.

### Recommended Tightening Torques

#### A) Single hole Fixing Receptacle ( Panel Nut tightening)

Shell Size	8	10	12	14	16	18	20	22	24
Nm	3.73	4.07	6.78	7.34	8.25	9.26	11.98	13.9	15.03
Lbf.ins	33	36	60	65	73	82	106	123	133

#### B) Accessory Tightening

Shell Size	8	10	12	14	16	18	20	22	24
Nm	3.79-3.96	3.96-4.52	4.52-5.09	5.09-5.65	5.65-6.78	6.78-7.91	8.48-9.04	9.61-10.17	10.74-11.3
Lbf.ins	25-40	35-40	40-45	45-50	55-60	65-70	75-80	85-90	95-100

### Crimping Tool

Contact size	Crimp Tool	Turret Head (ASTRO)
20	M22520/1-01	650106
16		



### Insertion & Removal Tool



Contact size	Insertion Removal Tool Part Number
20	62IN-IR-20
16	62IN-IR-16



To obtain a specific connector number, write down the connector number from the typical example below. Only inserts shown on page 5 can be specified. Connectors are delivered with protective dust caps. Deviations specified on page 15 must be included at the end of the connector number whenever required.

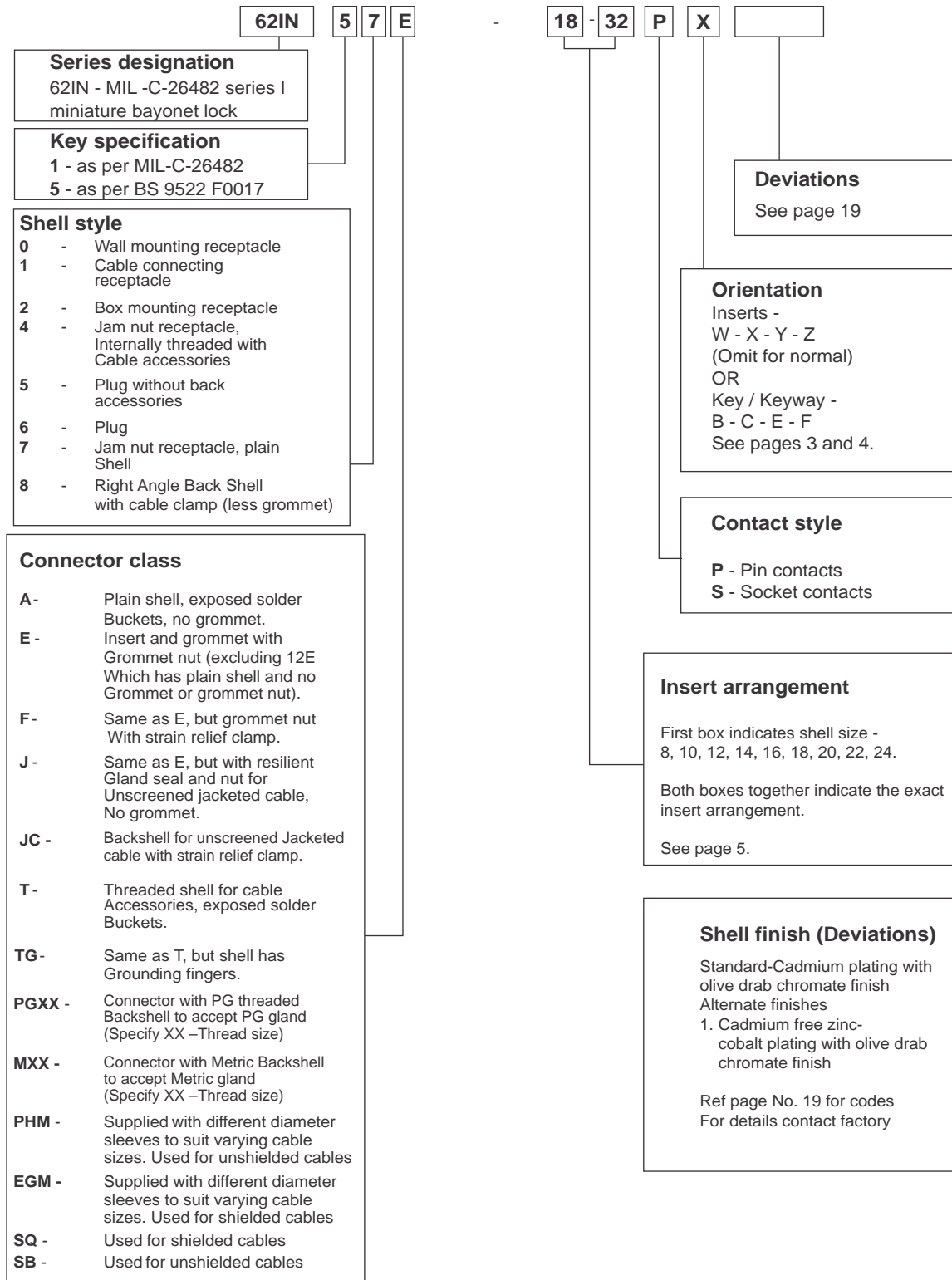

Notice: All information, including illustrations given herein is believed to be accurate at the time of printing. In lieu of design advances, Amphenol reserves the right to change specifications without notice. This publication AC6201 07/17 supersedes all existing Amphenol literature on 62IN series connectors.

## NORTH AMERICA

### Sales & Product Support

Amphenol PCD  
72 Cherry Hill Drive  
Beverly, MA 01915 USA  
Tel: +1-978-624-3400  
Fax: +1-978-927-1513  
info@amphenolpcd.com  
www.amphenolpcd.com  
www.backshellworld.com

Amphenol Aerospace Operations  
40-60, Delaware Avenue  
Sidney, NY 13838-1395  
Tel: +1-607-563-5011  
Fax: +1-607-563-5357

Amphenol Canada  
Meford Drive  
Scarborough,  
ON M1B 2X6  
Tel: +416-291-4401  
Fax: +416-292-0647

Amphenol Fiber Systems International  
1300 Central Expressway North  
Suite 100 Allen, Texas 75013, USA  
Tel: +1-214-547-2400  
Fax: +1-214-547-9344

## EUROPE

### France

Amphenol Socapex S.A.S.  
948, Promenade de l'Arve  
Bp29, Thyez Cedex  
74311, France  
Tel: +33-4-5089-2800  
Fax: +33-4-5096-1941

### United Kingdom

Amphenol Limited  
Thanet Way, Whitstable  
Kent CT5 3JF, England  
Tel: +44-1227-773-200  
Fax: 44-1227-276-571

### Germany

Amphenol-Air LB GmbH  
Am Kleinbahnhof 4  
Saarlouis  
D-66740, Germany  
Tel: 49-6831-9810-00  
Fax: 49-6831-9810-30

### Italy

Via Barbaiana 5  
20020 Lainate (Milano)  
Italy  
Tel: +39-02-93254.209  
+39-02-93254.214  
Fax: +39-02-93254-444

### Center & East Europe

Amphenol  
Wiener Gasse 68  
2380 Perchtoldsdorf  
Tel: +43-699-10396071  
Fax: +43 699 40396071

Amphenol Air-LB  
Immeuble Le Doublon  
11, Avenue Dobonnet  
Courbevoie-Cedex  
92407, France  
Ph: +33-1-4905-3000  
Fax: +33-1-4905-3043

### Spain

Amphenol Iberica  
Edificio Burgosol Oficina  
N 55 C/Comunidad de  
Madrid 35 bis -  
Las Rozas (Madrid)  
Tel: +34-91-6407302  
+34-91-6407306  
Fax: +34-91-6407307

### Austria

Amphenol Austria  
Wiener Gasse 68  
2380, Erchtoldsdarf,  
Austria  
Tel: + 43-69910396071  
Fax: + 43-69940306071

### Holland

Amphenol Benelux  
Zademaker 121  
NL-2401 PD Alphen  
aan den Rijn Holland  
Tel: +31-172-444903  
Fax: +31-172 240254

### Sweden

Amphenol  
Industrial and Military &  
Aerospace  
Nordic & Baltic  
Military Phone/  
Mobile +46702129200  
Industrial +46 767909560

## ASIA

### India

Amphenol Interconnect India Pvt. Ltd.  
105 Bhosari Industrial Area  
Pune-411026, India  
Tel: +9120-3068-8305  
Fax: +9120-2712-9158

### Japan

Amphenol Japan  
471-1, Deba, Ritto City  
Shiga 520-3041, Japan  
Tel: +81-77-553-8501  
Fax: +81-77-551-2200

### Singapore

Amphenol East Asia Ltd.  
72 Bendemeer Road  
# 03-33 Luzerne  
Singapore 339 941  
Tel: 65-6294-2128  
Fax: 65-6294-3522

### China

Amphenol PCD Shenzhen  
3/F Building, A4 Songbai  
Industrial Park  
East Road of Minghuan  
Gongming Town, Baon District  
Shenzhen, China  
Tel: +86-755-8173-8000  
Fax: +86-755-8173-8180

Amphenol Interconnect India Pvt. Ltd.  
61 Electronics City  
Bangalore-560 100, India  
Ph: +9180-2852-3838  
Fax: +9180-2852-0418

### Korea

Amphenol Daeshin Electronics  
558 SoSa, SongNae, Bucheon-City  
Kyunggi-Do, Korea 420-130  
Tel: +82-32-610-3800  
Fax: +92-32-673-2507

## ROW

### Australia

Amphenol Australia Pty Ltd  
2 Fiveways Boulevard  
Keysborough  
VIC 3173  
Ph: +61-3-8796-8888  
Fax: +61-3-8796-8801

### Africa

Amphenol South Africa  
30 Impala Road  
2196 Sandton-Chistlehurst  
South Africa  
Tel: +27-11-783-9517  
Fax: +27-11-783-9519

### Russia

Amphenol Russia  
8-2 Yaroslavskaja Str  
129164 Moscow, Russia  
Tel: +7-495-937-6341  
Fax: +7-495-937-6319

### Argentina

Amphenol Argentina  
Avenida Callao 930  
2nd Floor, Office B Plaza  
C1023AAP Buenos Aires  
Argentina  
Tel: 54-11-4815-6886  
Fax: 54-11-4814-5779

### Israel

Bar-Tec Ltd.  
P.O. Box 279  
Kfar Sava, 44102 Israel  
Tel: +972-9-7644100  
Fax: +972-9-7674324

### Maslak

34396 Istanbul  
Tel: +90-212-335-2501  
Fax: +90-212-335-2500

### Brazil

Amphenol do Brasil Ltda  
Rua Diogo Moreira 132  
CEP 05423-010  
Sao Paulo-SP, Brazil  
Tel: +55-11-3815-1003  
Fax: +55-11-3815-1629

# Amphenol

*A Global Company*



Pune Operations



Bangalore Operations

# Amphenol

Interconnect India Pvt. Ltd.

## Manufacturing Locations

### Corporate Office & Pune Factory

105, Bhosari Industrial Area,  
Pune - 411 026.  
Tel.: 91 - 020 - 67360302  
Fax : 91 - 020 - 67360321  
rjohn@amphenol-in.com

### Exports

Tel.: 91 - 20 - 67360305, 67360353  
Email : svpatil@amphenol-in.com

### Bangalore Factory

61 Keonics Electronic City  
Hosur Road, Bangalore - 560 102  
Tel.: 91 - 80 - 66790900/910/937  
Email : shrikantgramopadhye  
@amphenol-in.com

## Marketing Locations

### Marketing Headquarters

Tel.: 91 - 020 - 67360303,67360304  
Fax : 91 - 020 - 67360321  
Email: vbhavsar@amphenol-in.com  
sales@amphenol-in.com

### Western Region

Tel. : 91- 20- 67360334  
Email : sunilp@amphenol-in.com

### Northern & Eastern Region

A-421, Pacific Business Park  
Plot No. 37/1, Sahibabad Indst. Area,  
Site IV, Ghaziabad (UP) - 201 010.  
Mobile : 91-9910211399  
Email : sunily@amphenol-in.com

### Southern Region

No. 1115, 22nd Main Road,  
11th Cross sector - 1, HSR Layout  
Bangalore - 560 102.  
Tel.: 91 - 80 - 49530341, 49530345  
Fax : 91 - 80 - 49538697  
Email : kmanoj@amphenol-in.com

### Central Region

107, 1st Floor, 'Am Sri Classic',  
Sarojinidevi Road, Secunderabad - 500 003.  
Telefax : 91- 40-66332906  
Email : pprasad@amphenol-in.com

[www.amphenol-in.com](http://www.amphenol-in.com)



# Mouser Electronics

Authorized Distributor

Click to View Pricing, Inventory, Delivery & Lifecycle Information:

## Amphenol:

[62IN-16F-10-6S](#) [62IN12E106P4624](#) [62IN57A1412P](#) [62IN57A1412S](#) [62IN-3115-20-610-BG](#)  
[62IN12E1210PW2194624](#) [62IN-10-PG9](#) [62IN16PG9G106S4M](#) [62IN16F108P](#) [62IN16J108P622](#) [62IN12E106P](#) [62IN-](#)  
[11F-12-14P](#) [62IN-16F-12-14S](#) [62IN-16F-18-32S](#) [62IN12E84P4622](#) [62IN-16F-8-4P4622](#) [62IN16J1214P622](#)  
[62IN12E82P](#)