

# SLPMR25-690P12

## Safety Technology – Receiver

### Integrated Muting Function

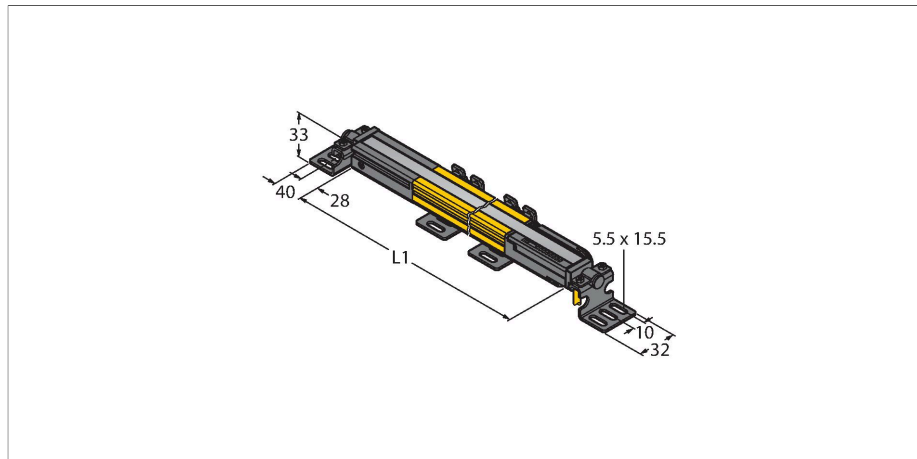

#### Features

- Cable with male end M12 x 1, 8-pin, 300 mm
- Protection class IP65
- Flat housing without blind zone
- Adjustments via DIP switch
- Resolution can be reduced
- Blanking function
- Operating voltage: 24 VDC ± 15 %
- Resolution 25 mm
- Scan field 690 mm (L1)
- Mounting bracket included in delivery

#### Wiring diagram

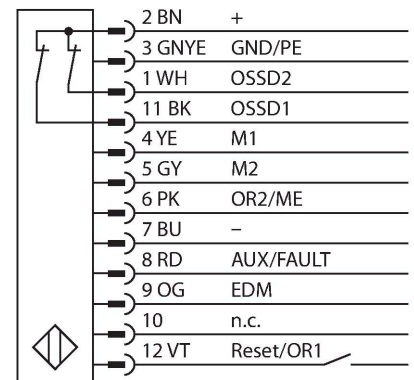

#### Functional principle

The high-resolution safety light screen is emitter and receiver in one without blind zone. As the system is optically synchronized, emitter/receiver wiring is superfluous. The receiver's safety switching outputs are directly connected to a load relay (e.g. IM-T-9A) and trigger an immediate stop of dangerous machine cycles. Personnel safety category PLe acc. to ISO 13849-1 is fulfilled through 2-channel monitoring of the switching device and the principle of diverse redundancy by which two processors control each other mutually.

#### Technical data

Type	SLPMR25-690P12
ID	3084499
<b>Optical data</b>	
Function	Light screen
Optical resolution	25 mm
Range	0...7000 mm
Scan field	690 mm
Number of beams	69
With muting function	yes
Scan Code	Adjustable
<b>Electrical data</b>	
Operating voltage	20...28 VDC
Residual ripple	< 10 % U <sub>ss</sub>
DC rated operational current	≤ 150 mA
Current consumption non-actuated	≤ 150 mA
No-load current	≤ 275 mA
Max. current safe output	500 mA
Short-circuit protection	yes
Reverse polarity protection	yes
Output function	2 x NC (normally closed), 2 x PNP
Current output	0...500 mA
Number of safe semiconductor outputs	2
Response time typical	< 12.5 ms
With restart interlock	yes
Blanking function	yes

## Technical data

Mechanical data	
Design	Rectangular, EZ-Screen LP
Dimensions	26 x 28 x 689 mm
Housing material	Metal, AL, Yellow polyester
Lens	plastic, Acryl
Cascadable	No
Electrical connection	Cable with connector, M12 × 1, 0.3 m
Number of cores	12
Ambient temperature	0...+55 °C
Protection class	IP65
Power-on indication	LED, Green
Switching state	2-color LED, Red
Tests/approvals	
Vibration resistance	10–55 Hz at 0.35 mm
Shock test	10 g at 16 ms (6000 cycles)
Approvals	CE, cTUVus