

SLPCE25-690P8

Personnel Safety, Light Screen – Emitter Cascadable

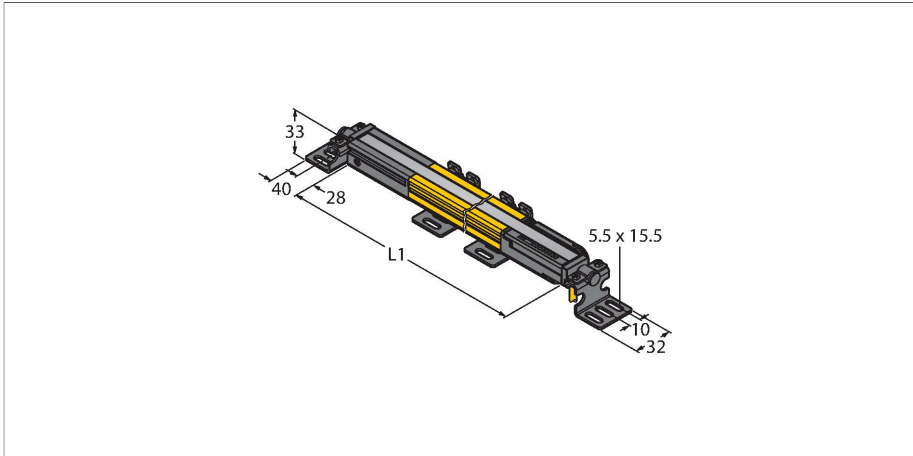

Technical data

Type	SLPCE25-690P8
ID	3083612
Optical data	
Function	Light screen
Light type	IR
Wavelength	850 nm
Optical resolution	25 mm
Range	100...7000 mm
Scan field	690 mm
Number of beams	35
With muting function	no
Scan Code	Adjustable
Electrical data	
Operating voltage	20...28 VDC
Residual ripple	< 10 % U _{ss}
DC rated operational current	≤ 60 mA
Current consumption non-actuated	≤ 60 mA
No-load current	≤ 100 mA
Short-circuit protection	yes
Reverse polarity protection	yes
Response time typical	< 12.5 ms
Blanking function	yes
Mechanical data	
Design	Rectangular, EZ-Screen LP
Dimensions	26 x 28 x 689 mm
Housing material	Metal, AL, Yellow polyester

Features

- Cable with male end M12 × 1, 8-pin, 300 mm
- Connection to cascadable nodes via DEE2R-8...
- Protection class IP65
- Flat housing without blind zone
- Scan code adjustable via DIP switch
- Operating voltage: 24 VDC ± 15 %
- Resolution 25 mm
- Scan field 690 mm (L1)
- Personnel safety Cat 4, PL e acc. to EN ISO 13849-1:2008
- Type 4 according to IEC 61496-1,-2
- SIL 3 to IEC 61508

Wiring diagram

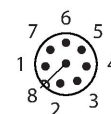
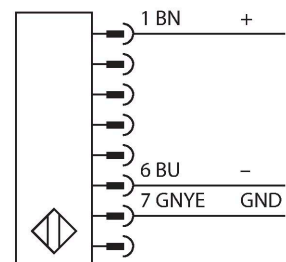

Technical data

Lens	plastic, Acrylic
Cascadable	Yes
Electrical connection	Cable with connector, M12 × 1, 300 m
Number of cores	8
Ambient temperature	0...+55 °C
Protection class	IP65
Power-on indication	LED, Green
Switching state	2-color LED, Red
Tests/approvals	
Vibration resistance	10-55 Hz at 0.35 mm
Shock test	10 g at 16 ms (6000 cycles)
Approvals	CE, cTUVus, PL e acc. to ENISO 13849-1:2008, SIL 3 acc. to IEC 61508

Functional principle





The high-resolution safety light curtain is emitter and receiver in one without blind zone. As the system is synchronized optically, wiring between emitter and receiver is redundant. The safety switching outputs of the receiver are directly connected to a load relay (e.g. IM-TA9A) and trigger an immediate stop of the dangerous machine cycle. The switching device with 2-channel monitoring, diverse redundant designed and mutual processor control, complies with the personnel safety category PLe acc. to ISO 13849-1.

Accessories

LPA-MBK-11	3082841	LPA-MBK-12	3082842
	Mounting bracket, retainer for closure caps, 14-ga. steel, galvanized, black, 360 ° sensor rotation, incl.2 pcs. with screw set		Mounting bracket, side mounting, 14-ga. steel, galvanized, black, +10°/-30° sensor rotation, incl.1 pcs. with screw set
LPA-MBK-20	3082853	LPA-MBK-22	3082844
	Mounting bracket, wall mounting, 12-ga. steel, galvanized, black, in combination with LPA-MBK-11/ -12/ -13, incl. 1 pcs. and screw set		Mounting bracket, wall mounting, 14-ga. steel, galvanized, black, in combination with LPA-MBK-11, incl. 2 pcs. and screw set
LPA-MBK-21	3082845	LPA-MBK-90	3082846
	Mounting bracket, side mounting, 14-ga. steel, galvanized, black, +10°/-30° sensor rotation, for mounting of cascable EZ-Screen LP, adjustable orientation 90° to 180 °		Mounting bracket, side mounting, 14-ga. steel, galvanized, black, +10°/-30° sensor rotation, for mounting of cascable EZ-Screen LP, firm orientation 90 °
LPA-MBK-120	3082847	LPA-MBK-135	3082848
	Mounting bracket, side mounting, 14-ga. steel, galvanized, black, +10°/-30° sensor rotation, for mounting of cascable EZ-Screen LP, firm orientation 120°		Mounting bracket, side mounting, 14-ga. steel, galvanized, black, +10°/-30° sensor rotation, for mounting of cascable EZ-Screen LP, firm orientation 135 °
LPA-MBK-180	3082849		
	Mounting bracket, side mounting, 14-ga. steel, galvanized, black, +10°/-30° sensor rotation, for mounting of cascable EZ-Screen LP, firm orientation 180 °		

Accessories

Dimension drawing	Type	ID	
	DEE2R-81D	3072205	Connection cable, PVC, yellow, length: 0.31 m, female M12 x 1 - male M12, 8-pin
	DEE2R-83D	3072206	Connection cable, PVC, yellow, length: 0.91 m, female M12 x 1 - male M12, 8-pin

Dimension drawing	Type	ID	
	DEE2R-88D_	3072635	Connection cable, PVC, yellow, length: 2.44 m, female M12 x 1 - male M12, 8-pin
	DEE2R-815D	3072207	Connection cable, PVC, yellow, length: 4.57 m, female M12 x 1 - male M12, 8-pin
	DEE2R-825D	3072208	Connection cable, PVC, yellow, length: 7.62 m, female M12 x 1 - male M12, 8-pin
	DEE2R-850D	3072209	Connection cable, PVC, yellow, length: 15.2 m, female M12 x 1 - male M12, 8-pin
	DEE2R-875D	3072210	Connection cable, PVC, yellow, length: 22.9 m, female M12 x 1 - male M12, 8-pin
	DEE2R-8100D	3072211	Connection cable, PVC, yellow, length: 30.5 m, female M12 x 1 - male M12, 8-pin
	QDE-815D	3070883	Connection cable for safety light screens, PVC, yellow, length 4.57 m, female connection, M12 x 1, 8-pin
	QDE-825D	3070884	Connection cable for safety light screens, PVC, yellow, length 7.62 m, female connection, M12 x 1, 8-pin
	QDE-850D	3070885	Connection cable for safety light screens, PVC, yellow, length 15.3 m, female connection, M12 x 1, 8-pin
	QDE-875D	3071466	Connection cable for safety light screens, PVC, yellow, length 22.9 m, female connection, M12 x 1, 8-pin
	QDE-8100D	3071467	Connection cable for safety light screens, PVC, yellow, length 30.5 m, female connection, M12 x 1, 8-pin
	CSB-M1280M1280	3075375	Y-piece, PVC, yellow, with male M12 x 1, 8-pin on 2 x 0.3 m cable, PVC, yellow, with female M12 x 1, 8-pin
	CSB-M1281M1281	3073252	Y-piece, PVC, yellow, length: 0.3 m with male, M12 x 1, 8-pin on 2 x 0.3 m cable, PVC, yellow, with female, M12 x 1, 8-pin
	CSB-M1288M1281	3073253	Y-piece, PVC, yellow, length: 2.5 m with male, M12 x 1, 8-pin on 2 x 0.3 m cable, PVC, yellow, with female, M12 x 1, 8-pin
	CSB-M12815M1281	3073254	Y-piece, PVC, yellow, length: 4.6 m with male, M12 x 1, 8-pin on 2 x 0.3 m cable, PVC, yellow, with female, M12 x 1, 8-pin
	CSB-M12825M1281	3073255	Y-piece, PVC, yellow, length: 7.6 m with male, M12 x 1, 8-pin on 2 x 0.3 m cable, PVC, yellow, with female, M12 x 1, 8-pin
	DEE2R-88D	3094306	Connection cable, PVC, yellow, length: 2.44 m, M12 x 1 female connector, 8-pin, on M12 x 1 male connector, 8-pin