

# Q45AD9FP

## Photoelectric Sensor – Photoelectric Sensor for Plastic Fibers

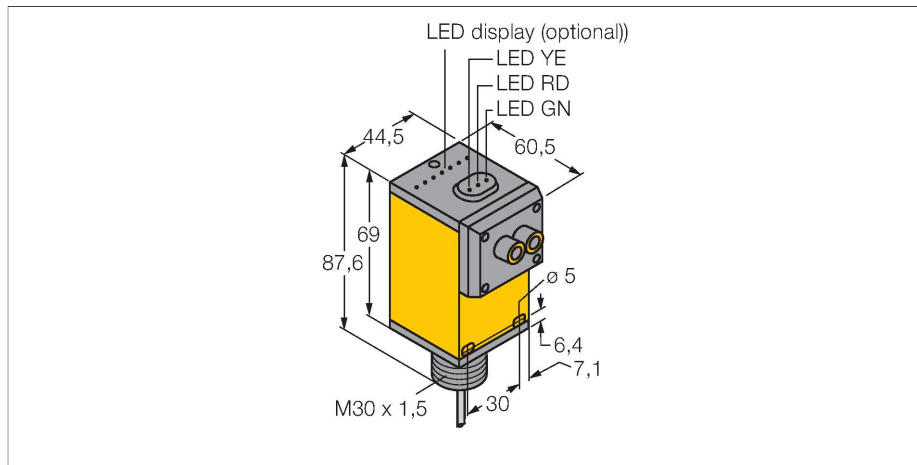

### Features

- Cable, PVC, 2 m
- Protection class IP67
- Sensitivity adjusted via potentiometer
- Adapter set PFK-B for connecting plastic optical fibers are available separately
- Operating voltage: 5...15 VDC
- NAMUR output: dark  $\leq$  1.2 mA ; light  $\geq$  2.1 mA
- Acc. to EN 60947-5-6 (NAMUR)
- ATEX category II 1 G, Ex zone 0

### Wiring diagram

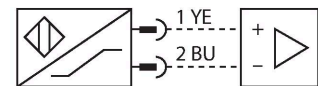

### Technical data

Type	Q45AD9FP
ID	3037622
<b>Optical data</b>	
Function	Fiber optic sensor
Operating mode	Plastic fiber
Fiber-optic type	plastic
Light type	Red
Wavelength	660 nm
<b>Electrical data</b>	
Voltage	Nom. 8.2 VDC
Current consumption non-actuated	$\leq$ 1 mA
Actuated current consumption	$\geq$ 2.1 mA
No-load current	$\leq$ 2.1 mA
Output function	Light operation, NAMUR
Switching frequency	$\leq$ 100 Hz
Response time typical	$<$ 5 ms
Setting option	Potentiometer
<b>Mechanical data</b>	
Design	Rectangular, Q45
Dimensions	60.5 x 44.5 x 87.6 mm
Housing material	Plastic, Thermoplastic material
Lens	plastic, Acrylic
Electrical connection	Cable, 2 m, PVC
Number of cores	2
Core cross-section	0.5 mm <sup>2</sup>
Ambient temperature	-40...+70 °C
Relative humidity	0...90 %

### Functional principle

Glass or fibre optic sensors are the optimum choice for high temperature or space restricted applications. Fibre optics transfer the light from the sensor to a remote object. Individual fibre optics are used for opposed mode sensing, whereas bifurcated fibre optics are suited for retro-reflective or diffuse mode operation.

Excess gain curve  
Excess gain in relation to the distance

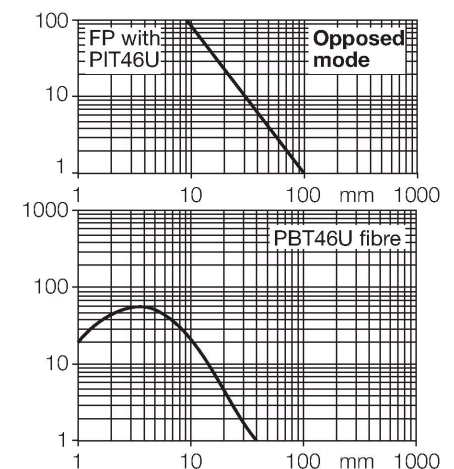

## Technical data

Protection class	IP67
Special features	Wash down
Switching state	LED, Red
Excess gain indication	LED, flashing
<b>Tests/approvals</b>	
MTTF	67 years acc. to SN 29500 (Ed. 99) 40 °C
Approvals	CE, FM, CSA
Approvals	ATEX II 1G ATEX II 2G ATEX II 3G
Device marking	Ⓔ II 1 G Ex ia IIC T5 Ga
Ignition protection category	Ex ia IIC T5
Ex approval acc. to conformity certificate	FM12ATEX0094X

## Accessories

SMB30A

3032723

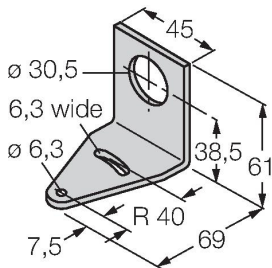

Mounting bracket, rectangular, stainless steel, for sensors with 30mm thread

SMB30FAM10

3011185

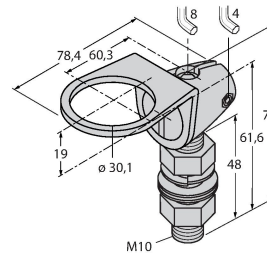

Mounting bracket, stainless steel, for M10 x 1.5 thread, thread length 30 mm

SMB30SC

3052521

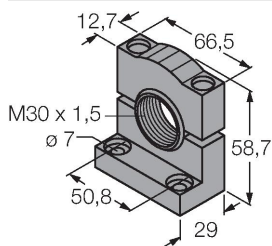

Mounting bracket, PBT black, for sensors with 30 mm thread, rotatable

PFK-B

3093520

Adapter set with 4 adapters per set to connect plastic optical fibers to Q45 fiber-optic sensors

## Accessories

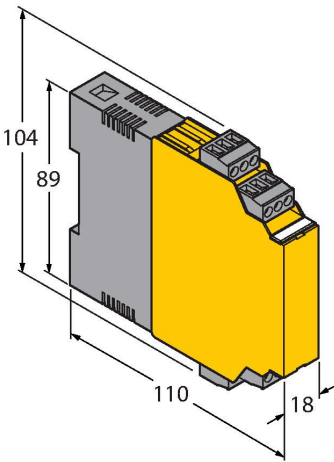
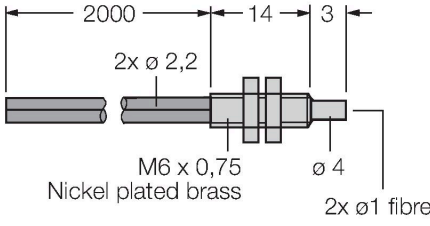
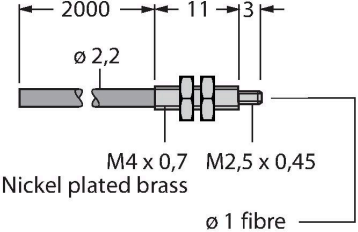
Dimension drawing	Type	ID	
 <p>Dimension drawing of IM1-22EX-R showing dimensions: 104 mm height, 89 mm height to terminal block, 110 mm length, and 18 mm width.</p>	IM1-22EX-R	7541231	Isolating switching amplifier, 2-channel; 2 relay outputs; input NAMUR signal; selectable ON/OFF mode for wire-break and short-circuit monitoring; adjustable output mode (NO / NC mode); removable terminal blocks; width 18 mm; universal power supply unit
 <p>Dimension drawing of PBT46U showing dimensions: 2000 mm length, 14 mm distance to thread, 3 mm distance to fiber, 2x ø 2,2 mm holes, M6 x 0,75 thread, ø 4 diameter, and 2x ø1 fibre.</p>	PBT46U	3025967	Plastic fiber-optic sensor, operating mode: Diffuse mode, threaded sleeve M3 x 0.75 mm, field wireable wire without end tip, polyethylene sheath, ambient temperatures -30 °C...+70 °C
 <p>Dimension drawing of PIT46U showing dimensions: 2000 mm length, 11 mm distance to thread, 3 mm distance to fiber, ø 2,2 mm hole, M4 x 0,7 thread, M2,5 x 0,45 thread, and ø 1 fibre.</p>	PIT46U	3026034	Plastic fiber-optic sensor, operating mode: Opposed mode, threaded sleeve M3 x 0.5 mm, field wireable wire without end tip, polyethylene sheath, ambient temperatures -30 °C...+70 °C

## Operating Instructions

Intended use	This device fulfills the directive 94/9/EC and is suited for use in explosion hazardous areas according to EN60079-0:2009, -11:2012, -26:2007. In order to ensure correct operation to the intended purpose it is required to observe the national regulations and directives.
For use in explosion hazardous areas conform to classification	II 1 G (Group II, Category 1 G, electrical equipment for gaseous atmospheres).
Marking (see device or technical data sheet)	⊕ II 1 G and Ex ia IIC T5 Ga acc. to EN60079-0, -11 and -26
Local admissible ambient temperature	-25...+70 °C
Installation/Commissioning	<p>These devices may only be installed, connected and operated by trained and qualified staff. Qualified staff must have knowledge of protection classes, directives and regulations concerning electrical equipment designed for use in explosion hazardous areas. Please verify that the classification and the marking on the device comply with the actual application conditions.</p> <p>This device is only suited for connection to approved Exi circuits according to EN 60079-0 and EN 60079-11. Please observe the maximum admissible electrical values. After connection to other circuits the sensor may no longer be used in Exi installations. When interconnected to (associated) electrical equipment, it is required to perform the "Proof of intrinsic safety" (EN60079-14).</p>
Installation and mounting instructions	<p>Avoid static charging of cables and plastic devices. Please only clean the device with a damp cloth. Do not install the device in a dust flow and avoid build-up of dust deposits on the device. If the devices and the cable could be subject to mechanical damage, they must be protected accordingly. They must also be shielded against strong electro-magnetic fields. The pin configuration and the electrical specifications can be taken from the device marking or the technical data sheet. In order to avoid contamination of the device, please remove possible blanking plugs of the cable glands or connectors only shortly before inserting the cable or opening the cable socket.</p>
Service/Maintenance	Repairs are not possible. The approval expires if the device is repaired or modified by a person other than the manufacturer. The most important data from the approval are listed.